



Hobbie Greenhouses

Product Information Guide

for
Authorized Palram Dealers



PALRAM APPLICATIONS

2 0 0 7

General Overview



PALRAM is global manufacturer of thermoplastic products for industry, architecture, advertising, and agriculture. The company has manufacturing facilities in Israel, England, China, and the USA. Over the course of more than 40 years, PALRAM has been a leader in many product categories, including polycarbonate and PVC covering for Do-It-Yourself and Commercial Greenhouse Growers. For detailed corporate information about PALRAM, it's history, and it's vision, visit www.palram.com.

In 2002, PALRAM introduced it's first ever-line of hobby greenhouse kits to the European market, the USA, and Canada. PALRAM has established a position of strength by marketing it's own products through various channels under several brands. PALRAM has also worked with partners to attain market share. In 2006, PALRAM re-organized it's manufacturing, marketing, brand, and sales strategy in order to achieve continued growth and to create greater awareness of the PALRAM brand.

Now, you and your business have an opportunity to join PALRAM as it continues to build it's leadership position in Personal Greenhouses market with the introduction of the "PALRAM HOME & GARDEN PRODUCTS" brand.



There are two objectives for establishing this brand: build awareness of the PALRAM name; and build a foundation for a line of products that span across the entire HOME & GARDEN market segment.

SILVER LINE

SERIES GREENHOUSES

The highly successful SILVER LINE series greenhouse will be marketed under the PALRAM HOME & GARDEN Products brand. PALRAM's SILVER LINE products maintain the elegant, traditional designs found throughout Europe, but improves performance with highly impact-resistant polycarbonate glazing, compact packaging, and very competitive pricing. To complement the SILVER LINE, PALRAM recently introduced the 4'x2' LEAN-TO, and a 3'x3' COLD FRAME, both of which are covered with PALRAM's own high quality polycarbonate. Please continue and see the products that we believe you'll be most successful with and why.



Silver Line

SERIES GREENHOUSES

SILVER LINE GREENHOUSE 6' x 10'



► Model: Silver Line 6'x10' Greenhouse

Assembled dimensions: 315cm Lx193cm W x 203cm H
(124"L x 75.98"W x 79.92"H)

Manufacture: Palram Applications
Product line: Silver Line Series

Mfg.item#: 700442
Item UPC: 894275000236
EAN: 7290010027187

Targeted retail price:



► Product Highlights

- Single Layer, Crystal Clear Polycarbonate panels are virtually unbreakable
- 197cm/6.5' of head room
- Galvanized steel base and manual roof vent included
- Average set-up time 4 to 5 hours
- Sturdy, corrosion-resistant aluminum frame
- 100% UV Protection, blocks out 99.9% of harmful solar radiation

► Merchandising Highlights

- Polypropylene cartons allows outdoor storage
- Full-color labels reduce need for POP literature
- POP literature & outdoor posters available
- Cartons can easily be stored in standard warehouse racks
- No glass or other breakable item in carton

► Logistic Info

Pallet Specification 40' HC	Dimension	Weight
Ctn. 1 of 2: 40 units/pallet	317 x 91 x 120cm 124.8" x 35.82" x 47.24"	1,300 kg. 2,860 lbs.
Ctn. 2 of 2: 62 units/pallet	118 x 129 x 220cm 46.45" x 50.78" x 86.61"	1,100 kg. 2,420 lbs.

Individual Selling Unit	Dimension	Weight
Carton 1 of 2	317 x 17 x 13cm 124.8" x 6.69" x 5.11"	31 kg. 68.2 lbs.
Carton 2 of 2	118 x 64 x 7cm 46.45" x 25.19" x 2.75"	17 kg. 37.4 lbs.

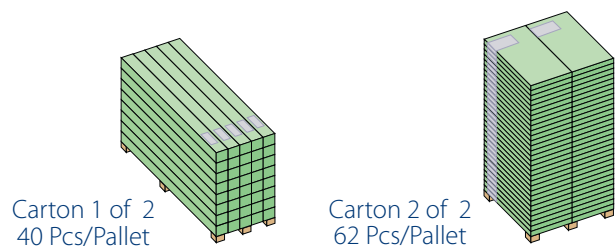
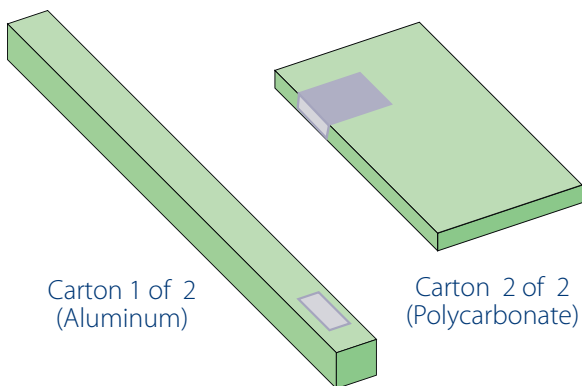

Container Specification	Units	Weight
40' Hi Cube	400	20,100 kg. 44,220 lbs.

- * Carton 1: 10 pallets of 40 units per pallet
- * Carton 2: 6 pallets of 62 units per pallet & 1 pallets of 28 units

Europe
UK
Israel
USA
Australia
Far East



PALRAM APPLICATIONS LTD.
Ramat Yohanan, 30035, ISRAEL
Tel ► (972) 4 8459844
Fax ► (972) 4 8459848
applications@palram.com

EUROPE
PALRAM EUROPE LTD.
Tel ► (44) 1302 380 777
Fax ► (44) 1302 380 788
sales.europe@palram.com

ISRAEL
PALRAM ISRAEL LTD.
Tel ► (972) 4 8459 900
Fax ► (972) 4 8459 980
palram@palram.com

USA
PALRAM AMERICAS
Tel ► 610 285 9918
Fax ► 610 285 9928
palramamericas@palram.com

www.palram.com

GREEN LINE GREENHOUSE 6' x 10'



► Model: Green Line 6'x10' Greenhouse

Assembled dimensions: 315cm Lx193cm W x 203cm H
(124"L x 75.98"W x 79.92"H)

Manufacture: Palram Applications
Product line: Green Line Series

Mfg.item#: 700914
Item UPC: 894275000830
EAN: 7290010027330

Targeted retail price:



► Product Highlights

- Single Layer, Crystal Clear Polycarbonate panels are virtually unbreakable
- 197cm/6.5' of head room
- Green galvanized steel base and manual roof vent included
- Average set-up time 4 to 5 hours
- Sturdy, corrosion-resistant aluminum frame
- Forest green painted for added aesthetic quality
- 100% UV Protection, blocks out 99.9% of harmful solar radiation

► Merchandising Highlights

- Polypropylene cartons allows outdoor storage
- Full-color labels reduce need for POP literature
- POP literature & outdoor posters available
- Cartons can easily be stored in standard warehouse racks
- No glass or other breakable item in carton

► Logistic Info

Pallet Specification 40' HC	Dimension	Weight
Ctn. 1 of 2: 40 units/pallet	317 x 91 x 120cm 124.8" x 35.82" x 47.24"	1,300 kg. 2,860 lbs.
Ctn. 2 of 2: 62 units/pallet	118 x 129 x 220cm 46.45" x 50.78" x 86.61"	1,100 kg. 2,420 lbs.

Individual Selling Unit	Dimension	Weight
Carton 1 of 2	317 x 17 x 13cm 124.8" x 6.69" x 5.11"	31 kg. 68.2 lbs.
Carton 2 of 2	118 x 64 x 7cm 46.45" x 25.19" x 2.75"	17 kg. 37.4 lbs.

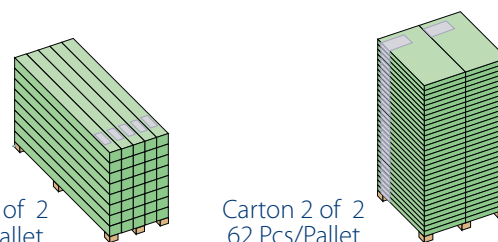
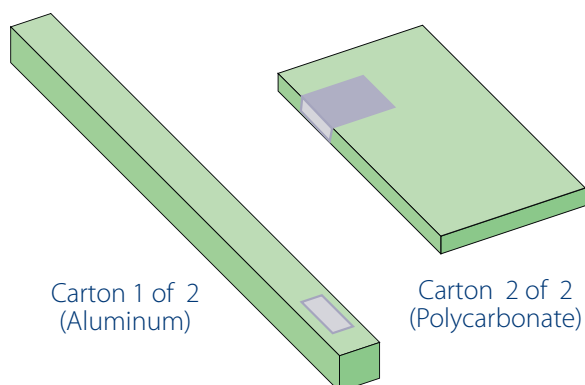

Container Specification	Units	Weight
40' Hi Cube	400	20,100 kg. 44,220 lbs.

- * Carton 1: 10 pallets of 40 units per pallet
- * Carton 2: 6 pallets of 62 units per pallet & 1 pallets of 28 units



PALRAM APPLICATIONS LTD.
Ramat Yohanan, 30035, ISRAEL
Tel ► (972) 4 8459844
Fax ► (972) 4 8459848
applications@palram.com

EUROPE
PALRAM EUROPE LTD.
Tel ► (44) 1302 380 777
Fax ► (44) 1302 380 788
sales.europe@palram.com

ISRAEL
PALRAM ISRAEL LTD.
Tel ► (972) 4 8459 900
Fax ► (972) 4 8459 980
palram@palram.com

USA
PALRAM AMERICAS
Tel ► 610 285 9918
Fax ► 610 285 9928
palramamericas@palram.com

www.palram.com

MULTI LINE GREENHOUSE 6' x 10'



► Model: Multi Line 6'x10' Greenhouse

Assembled dimensions: 315cm L x 193cm W x 203cm H
(124"L x 75.98"W x 79.92"H)

Manufacture: Palram Applications
Product line: Multi Line Series

Mfg.item#: 700938
Item UPC: 894275000847
EAN: 7290010027316

Targeted retail price:



► Product Highlights

- Multi wall clear Polycarbonate panels are virtually unbreakable
- 197cm/6.5' of head room
- Galvanized steel base and manual roof vent included
- Average set-up time 4 to 5 hours
- Sturdy, corrosion-resistant aluminum frame
- 100% UV Protection, blocks out 99.9% of harmful solar radiation

► Merchandising Highlights

- Polypropylene packages allows outdoor storage
- Full-color labels reduce need for POP literature
- POP literature & outdoor posters available
- Packages can easily be stored in standard warehouse racks
- No glass or other breakable item in carton
- Excellent thermal isolation with the polycarbonate Multi Wall panels.

► Logistic Info

Pallet Specification 40' HC	Dimension	Weight
Ctn. 1 of 2: 40 units/pallet	317 x 91 x 120cm 124.8" x 35.82" x 47.24"	1,300 kg. 2,860 lbs.
Ctn. 2 of 2: 38 units/pallet	118 x 129 x 250cm 46.45" x 50.78" x 98.42"	680 kg. 1,496 lbs.

Individual Selling Unit	Dimension	Weight
Carton 1 of 2	317 x 17 x 13cm 124.8" x 6.69" x 5.11"	31 kg. 68.2 lbs.
Carton 2 of 2	118 x 64 x 12cm 46.45" x 25.19" x 4.72"	16.5 kg. 36.3 lbs.

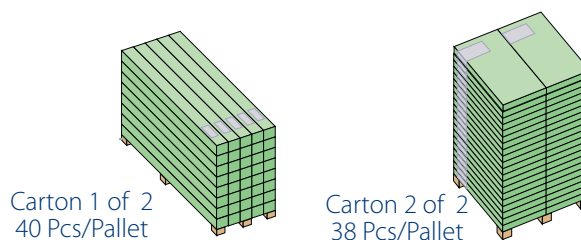
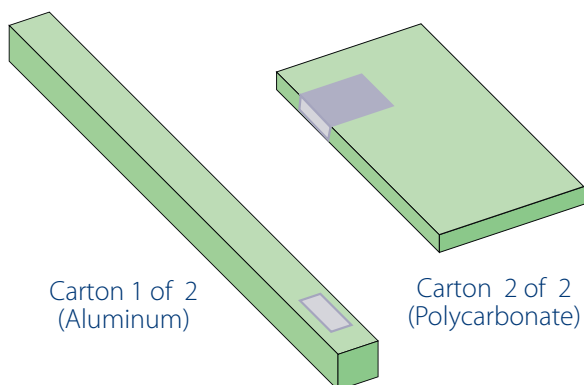

Container Specification	Units	Weight
40' Hi Cube	320	16,140 kg. 33,510 lbs.

- * Carton 1: 8 pallets of 40 units per pallet
- * Carton 2: 8 pallets of 38 units per pallet & 1 pallets of 16 units

Europe
UK
Israel
USA
Australia
Far East



PALRAM APPLICATIONS LTD.
Ramat Yohanan, 30035, ISRAEL
Tel ► (972) 4 8459844
Fax ► (972) 4 8459848
applications@palram.com

EUROPE
PALRAM EUROPE LTD.
Tel ► (44) 1302 380 777
Fax ► (44) 1302 380 788
sales.europe@palram.com

ISRAEL
PALRAM ISRAEL LTD.
Tel ► (972) 4 8459 900
Fax ► (972) 4 8459 980
palram@palram.com

USA
PALRAM AMERICAS
Tel ► 610 285 9918
Fax ► 610 285 9928
palramamericas@palram.com

www.palram.com

SILVER LINE GREENHOUSE 6' x 8'



► Model: Silver Line 6'x8' Greenhouse

Assembled dimensions: 255cm Lx193cm W x 203cm H
(100.39"L x 75.98"W x 79.92"H)

Manufacture: Palram Applications
Product line: Silver Line Series

Mfg.item#: 700360
Item UPC: 894275000243
EAN: 7290010027170

Targeted retail price:



► Product Highlights

- Single Layer, Crystal Clear Polycarbonate panels are virtually unbreakable
- 197cm/6.5' of head room
- Galvanized steel base and manual roof vent included
- Average set-up time 4 to 5 hours
- Sturdy, corrosion-resistant aluminum frame
- 100% UV Protection, blocks out 99.9% of harmful solar radiation

► Merchandising Highlights

- Polypropylene cartons allows outdoor storage
- Full-color labels reduce need for POP literature
- POP literature & outdoor posters available
- Cartons can easily be stored in standard warehouse racks
- No glass or other breakable item in carton

► Logistic Info

Pallet Specification 40' HC	Dimension	Weight
Ctn. 1 of 2: 48 units/pallet	255 x 108 x 120cm 100.39" x 42.51" x 47.24"	1,400 kg. 3,080 lbs.
Ctn. 2 of 2: 60 units/pallet	118 x 129 x 250cm 46.45" x 50.78" x 98.42"	950 kg. 2,090 lbs.

Individual Selling Unit	Dimension	Weight
Carton 1 of 2	255 x 17 x 13cm 100.39" x 6.69" x 5.11"	28 kg. 61.6 lbs.
Carton 2 of 2	118 x 63 x 7cm 46.45" x 25.19" x 2.75"	15 kg. 33 lbs.

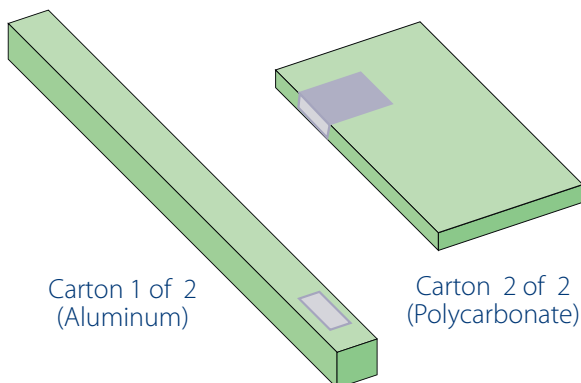

Carton 1 of 2
(Aluminum)

Carton 2 of 2
(Polycarbonate)

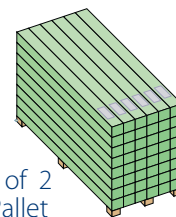

Carton 1 of 2
48 Pcs/Pallet

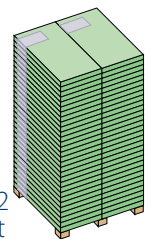

Carton 2 of 2
60 Pcs/Pallet

Container Specification	Units	Weight
40' Hi Cube	480	21,600 kg. 47,520 lbs.

- * Carton 1: 10 pallets of 48 units per pallet
- * Carton 2: 8 pallets of 60 units per pallet

Europe
UK
Israel
USA
Australia
Far East



PALRAM APPLICATIONS LTD.
Ramat Yohanan, 30035, ISRAEL
Tel ► (972) 4 8459844
Fax ► (972) 4 8459848
applications@palram.com

EUROPE
PALRAM EUROPE LTD.
Tel ► (44) 1302 380 777
Fax ► (44) 1302 380 788
sales.europe@palram.com

ISRAEL
PALRAM ISRAEL LTD.
Tel ► (972) 4 8459 900
Fax ► (972) 4 8459 980
palram@palram.com

USA
PALRAM AMERICAS
Tel ► 610 285 9918
Fax ► 610 285 9928
palramamericas@palram.com

www.palram.com

GREEN LINE GREENHOUSE 6' x 8'



► Model: Green Line 6'x8' Greenhouse

Assembled dimensions: 255cm Lx193cm W x 203cm H
(100.39"L x 75.98"W x 79.92"H)

Manufacture: Palram Applications
Product line: Green Line Series

Mfg.item#: 700913
Item UPC: 894275000298
EAN: 7290010027323

Targeted retail price:



► Product Highlights

- Single Layer, Crystal Clear Polycarbonate panels are virtually unbreakable
- 197cm/6.5' of head room
- Green galvanized steel base and manual roof vent included
- Average set-up time 4 to 5 hours
- Sturdy, corrosion-resistant aluminum frame
- Forest green painted for added aesthetic quality
- 100% UV Protection, blocks out 99.9% of harmful solar radiation

► Merchandising Highlights

- Polypropylene cartons allows outdoor storage
- Full-color labels reduce need for POP literature
- POP literature & outdoor posters available
- Cartons can easily be stored in standard warehouse racks
- No glass or other breakable item in carton

► Logistic Info

Pallet Specification 40' HC	Dimension	Weight
Ctn. 1 of 2: 48 units/pallet	255 x 108 x 120cm 100.39" x 42.51" x 47.24"	1,400 kg. 3,080 lbs.
Ctn. 2 of 2: 60 units/pallet	118 x 129 x 250cm 46.45" x 50.78" x 98.42"	950 kg. 2,090 lbs.

Individual Selling Unit	Dimension	Weight
Carton 1 of 2	255 x 17 x 13cm 100.39" x 6.69" x 5.11"	28 kg. 61.6 lbs.
Carton 2 of 2	118 x 63 x 7cm 46.45" x 25.19" x 2.75"	15 kg. 33 lbs

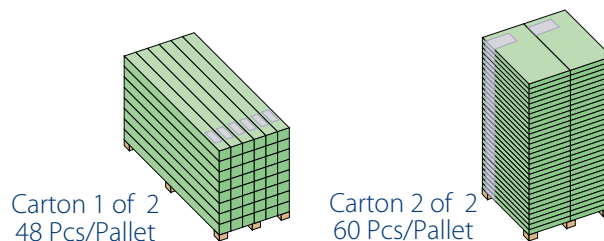
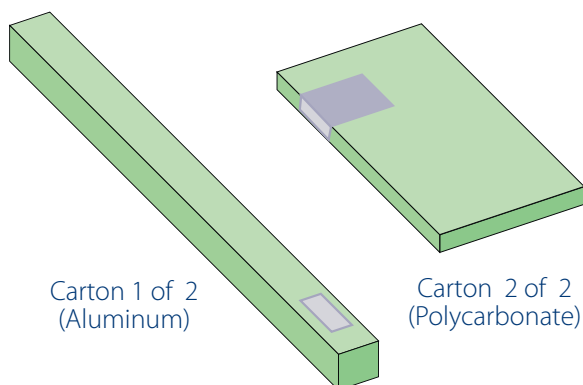

Container Specification	Units	Weight
40' Hi Cube	480	21,600 kg. 47,520 lbs.

- * Carton 1: 10 pallets of 48 units per pallet
- * Carton 2: 8 pallets of 60 units per pallet

Europe
UK
Israel
USA
Australia
Far East



PALRAM APPLICATIONS LTD.
Ramat Yohanan, 30035, ISRAEL
Tel ► (972) 4 8459844
Fax ► (972) 4 8459848
applications@palram.com

EUROPE
PALRAM EUROPE LTD.
Tel ► (44) 1302 380 777
Fax ► (44) 1302 380 788
sales.europe@palram.com

ISRAEL
PALRAM ISRAEL LTD.
Tel ► (972) 4 8459 900
Fax ► (972) 4 8459 980
palram@palram.com

USA
PALRAM AMERICAS
Tel ► 610 285 9918
Fax ► 610 285 9928
palramamericas@palram.com

www.palram.com

MULTI LINE GREENHOUSE 6' x 8'



► Model: Multi Line 6'x8' Greenhouse

Assembled dimensions: 255cm L x 193cm W x 203cm H
(100.39"L x 75.98"W x 79.92"H)

Manufacture: Palram Applications
Product line: Multi Line Series

Mfg.item#: 700985
Item UPC: 894275000311
EAN: 7290010027309

Targeted retail price:



► Product Highlights

- Multi wall clear Polycarbonate panels are virtually unbreakable
- 197cm/6.5' of head room
- Galvanized steel base and manual roof vent included
- Average set-up time 4 to 5 hours
- Sturdy, corrosion-resistant aluminum frame
- 100% UV Protection, blocks out 99.9% of harmful solar radiation

► Merchandising Highlights

- Polypropylene packages allows outdoor storage
- Full-color labels reduce need for POP literature
- POP literature & outdoor posters available
- Packages can easily be stored in standard warehouse racks
- No glass or other breakable item in carton
- Excellent thermal isolation with the polycarbonate Multi Wall panels.

► Logistic Info

Pallet Specification 40' HC	Dimension	Weight
Ctn. 1 of 2: 48 units/pallet	255 x 108 x 120cm 100.39" x 42.51" x 47.24"	1,400 kg. 3,080 lbs.
Ctn. 2 of 2: 44 units/pallet	118 x 129 x 250cm 46.45" x 50.78" x 98.42"	670 kg. 1,470 lbs.

Individual Selling Unit	Dimension	Weight
Carton 1 of 2	255 x 17 x 13cm 100.39" x 6.69" x 5.11"	28 kg 62 lbs.
Carton 2 of 2	118 x 64 x 10cm 46.45" x 25.19" x 3.93"	14 kg 31 lbs.

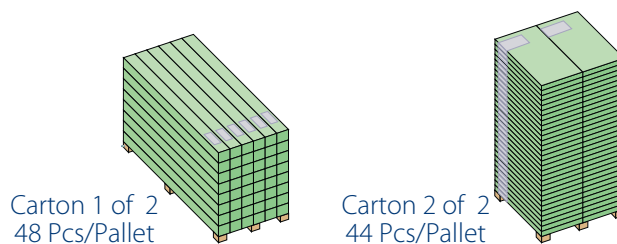
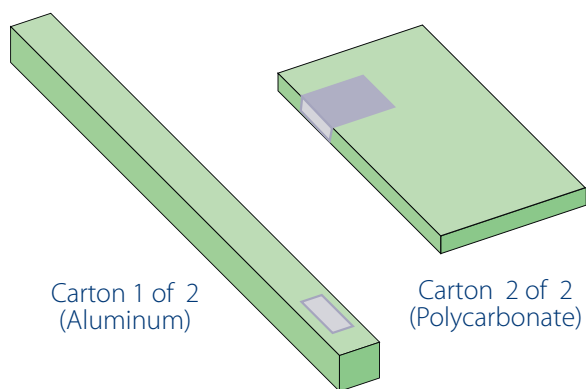

Container Specification	Units	Weight
40' Hi Cube	384	17,000 kg. 37,400 lbs.

- * Carton 1: 8 pallets of 48 units per pallet
- * Carton 2: 8 pallets of 44 units per pallet & 2 pallet of 16 units

Europe
UK
Israel
USA
Australia
Far East



PALRAM APPLICATIONS LTD.
Ramat Yohanan, 30035, ISRAEL
Tel ► (972) 4 8459844
Fax ► (972) 4 8459848
applications@palram.com

EUROPE
PALRAM EUROPE LTD.
Tel ► (44) 1302 380 777
Fax ► (44) 1302 380 788
sales.europe@palram.com

ISRAEL
PALRAM ISRAEL LTD.
Tel ► (972) 4 8459 900
Fax ► (972) 4 8459 980
palram@palram.com

USA
PALRAM AMERICAS
Tel ► 610 285 9918
Fax ► 610 285 9928
palramamericas@palram.com

www.palram.com

SILVER LINE GREENHOUSE 6' x 6'



► Model: Silver Line 6'x6' Greenhouse

Assembled dimensions: 193cm Lx193cm W x 203cm H
(75.98"L x 75.98"W x 79.92"H)

Manufacture: Palram Applications
Product line: Silver Line Series

Mfg.item#: 700926
Item UPC: 894275000205
EAN: 7290010027392

Targeted retail price:



► Product Highlights

- Single Layer, Crystal Clear Polycarbonate panels are virtually unbreakable
- 197cm/6.5' of head room
- Green galvanized steel base and manual roof vent included
- Average set-up time 4 to 5 hours
- Sturdy, corrosion-resistant aluminum frame
- Forest green painted for added aesthetic quality
- 100% UV Protection, blocks out 99.9% of harmful solar radiation

► Merchandising Highlights

- Polypropylene cartons allows outdoor storage
- Full-color labels reduce need for POP literature
- POP literature & outdoor posters available
- Cartons can easily be stored in standard warehouse racks
- No glass or other breakable item in carton

► Logistic Info

Pallet Specification 40' HC	Dimension	Weight
Ctn. 1 of 2: 48 units/pallet	240 x 108 x 120cm 94.48" x 42.51" x 47.24"	1,250 kg. 2,750 lbs
Ctn. 2 of 2: 60 units/pallet	118 x 129 x 240cm 46.45" x 50.78" x 94.48"	800 kg. 1,760 lbs.

Individual Selling Unit	Dimension	Weight
Carton 1 of 2	240 x 17 x 13cm 94.48" x 6.69" x 5.11"	25 kg. 55 lbs.
Carton 2 of 2	118 x 64 x 7cm 46.45" x 25.19" x 2.75"	12.5 kg. 27 lbs.

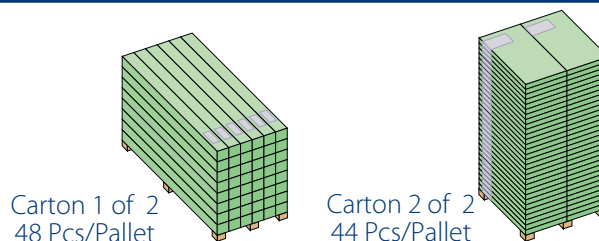
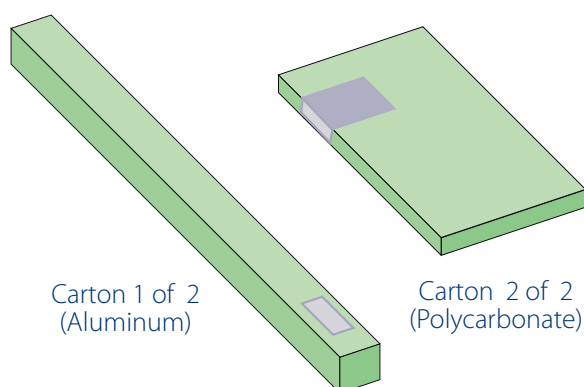

Container Specification	Units	Weight
40' Hi Cube	480	18,900 kg. 41,580 lbs.

- * Carton 1: 10 pallets of 48 units per pallet
- * Carton 2: 8 pallets of 60 units per pallet

Europe
UK
Israel
USA
Australia
Far East

PALRAM APPLICATIONS LTD.
Ramat Yohanan, 30035, ISRAEL
Tel ► (972) 4 8459844
Fax ► (972) 4 8459848
applications@palram.com

EUROPE
PALRAM EUROPE LTD.
Tel ► (44) 1302 380 777
Fax ► (44) 1302 380 788
sales.europe@palram.com

ISRAEL
PALRAM ISRAEL LTD.
Tel ► (972) 4 8459 900
Fax ► (972) 4 8459 980
palram@palram.com

USA
PALRAM AMERICAS
Tel ► 610 285 9918
Fax ► 610 285 9928
palramamericas@palram.com

www.palram.com

GREEN LINE GREENHOUSE 6' x 6'



► Model: Green Line 6'x6' Greenhouse

Assembled dimensions: 193cm Lx193cm W x 203cm H
(75.98"L x 75.98"W x 79.92"H)

Manufacture: Palram Applications
Product line: Green Line Series

Mfg.item#: 700925
Item UPC: 894275000281
EAN: 7290010027491

Targeted retail price:



► Product Highlights

- Single Layer, Crystal Clear Polycarbonate panels are virtually unbreakable
- 197cm/6.5' of head room
- Green galvanized steel base and manual roof vent included
- Average set-up time 4 to 5 hours
- Sturdy, corrosion-resistant aluminum frame
- Forest green painted for added aesthetic quality
- 100% UV Protection, blocks out 99.9% of harmful solar radiation

► Merchandising Highlights

- Polypropylene cartons allows outdoor storage
- Full-color labels reduce need for POP literature
- POP literature & outdoor posters available
- Cartons can easily be stored in standard warehouse racks
- No glass or other breakable item in carton

► Logistic Info

Pallet Specification 40' HC	Dimension	Weight
Ctn. 1 of 2: 48 units/pallet	240 x 108 x 120cm 94.48" x 42.51" x 47.24"	1,250 kg. 2,750 lbs
Ctn. 2 of 2: 60 units/pallet	118 x 129 x 240cm 46.45" x 50.78" x 94.48"	800 kg. 1,760 lbs.

Individual Selling Unit	Dimension	Weight
Carton 1 of 2	240 x 17 x 13cm 94.48" x 6.69" x 5.11"	25 kg. 55 lbs.
Carton 2 of 2	118 x 64 x 7cm 46.45" x 25.19" x 2.75"	12.5 kg. 27 lbs.

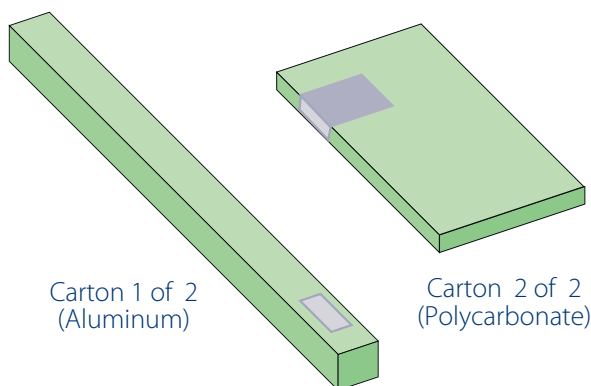

Carton 1 of 2
(Aluminum)

Carton 2 of 2
(Polycarbonate)

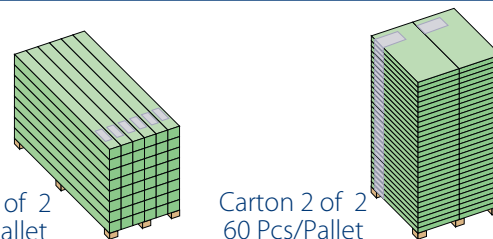

Carton 1 of 2
48 Pcs/Pallet

Carton 2 of 2
60 Pcs/Pallet

Container Specification	Units	Weight
40' Hi Cube	480	18,900 kg. 41,580 lbs.

* Carton 1: 10 pallets of 48 units per pallet
* Carton 2: 8 pallets of 60 units per pallet

Europe
UK
Israel
USA
Australia
Far East



PALRAM APPLICATIONS LTD.
Ramat Yohanan, 30035, ISRAEL
Tel ► (972) 4 8459844
Fax ► (972) 4 8459848
applications@palram.com

EUROPE
PALRAM EUROPE LTD.
Tel ► (44) 1302 380 777
Fax ► (44) 1302 380 788
sales.europe@palram.com

ISRAEL
PALRAM ISRAEL LTD.
Tel ► (972) 4 8459 900
Fax ► (972) 4 8459 980
palram@palram.com

USA
PALRAM AMERICAS
Tel ► 610 285 9918
Fax ► 610 285 9928
palramamericas@palram.com

www.palram.com

MULTI LINE GREENHOUSE 6' x 6'



► Model: Multi Line 6'x6' Greenhouse

Assembled dimensions: 193cm L x 193cm W x 203cm H
(75.98"L x 75.98"W x 79.92"H)

Manufacture: Palram Applications
Product line: Multi Line Series

Mfg.item#: 701055
Item UPC: 894275000588
EAN: 7290010027637

Targeted retail price:



► Product Highlights

- Multi wall clear Polycarbonate panels are virtually unbreakable
- 197cm/6.5' of head room
- Galvanized steel base and manual roof vent included
- Average set-up time 4 to 5 hours
- Sturdy, corrosion-resistant aluminum frame
- 100% UV Protection, blocks out 99.9% of harmful solar radiation

► Merchandising Highlights

- Polypropylene packages allows outdoor storage
- Full-color labels reduce need for POP literature
- POP literature & outdoor posters available
- Packages can easily be stored in standard warehouse racks
- No glass or other breakable item in carton
- Excellent thermal isolation with the polycarbonate Multi Wall panels.

► Logistic Info

Pallet Specification 40' HC	Dimension	Weight
Ctn. 1 of 2: 48 units/pallet	240 x 108 x 120cm 94.48" x 42.51" x 47.24"	1,250 kg. 2,750 lbs
Ctn. 2 of 2: 54 units/pallet	118 x 129 x 240cm 46.45" x 50.78" x 94.48"	720 kg. 1,584 lbs.

Individual Selling Unit	Dimension	Weight
Carton 1 of 2	240 x 17 x 13cm 94.48" x 6.69" x 5.11"	25 kg. 55 lbs.
Carton 2 of 2	118 x 64 x 7cm 46.45" x 25.19" x 2.75"	12.5 kg. 27 lbs.

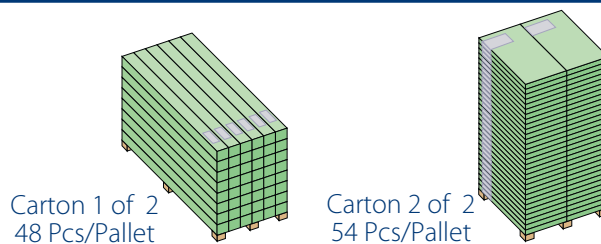
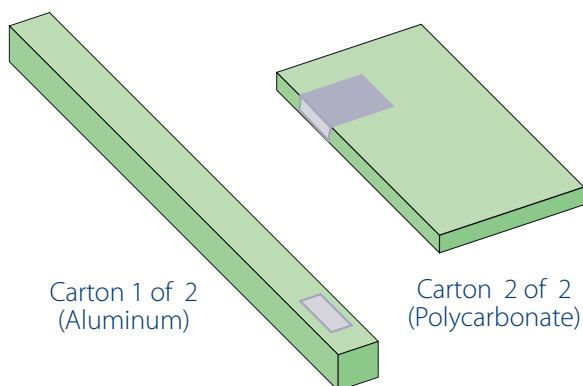

Container Specification	Units	Weight
40' Hi Cube	432	17,100 kg. 37,400 lbs.

* Carton 1: 9 pallets of 48 units per pallet
* Carton 2: 8 pallets of 54 units per pallet

Europe
UK
Israel
USA
Australia
Far East

PALRAM APPLICATIONS LTD.
Ramat Yohanan, 30035, ISRAEL
Tel ► (972) 4 8459844
Fax ► (972) 4 8459848
applications@palram.com

EUROPE
PALRAM EUROPE LTD.
Tel ► (44) 1302 380 777
Fax ► (44) 1302 380 788
sales.europe@palram.com

ISRAEL
PALRAM ISRAEL LTD.
Tel ► (972) 4 8459 900
Fax ► (972) 4 8459 980
palram@palram.com

USA
PALRAM AMERICAS
Tel ► 610 285 9918
Fax ► 610 285 9928
palramamericas@palram.com

www.palram.com

SILVER LINE GREENHOUSE 6' x 4'



► Model: Silver Line 6'x4' Greenhouse

Assembled dimensions: 140cm Lx193cm W x 203cmH
(55.11"L x 75.98"W x 79.92"H)

Manufacture: Palram Applications
Product line: Silver Line Series

Mfg.item#: 701034
Item UPC: 894275000267
EAN: 7290010027385

Targeted retail price:



► Product Highlights

- Single Layer, Crystal Clear Polycarbonate panels are virtually unbreakable
- 197cm/6.5' of head room
- Galvanized steel base and manual roof vent included
- Average set-up time 4 to 5 hours
- Sturdy, corrosion-resistant aluminum frame
- 100% UV Protection, blocks out 99.9% of harmful solar radiation

► Merchandising Highlights

- Polypropylene cartons allows outdoor storage
- Full-color labels reduce need for POP literature
- POP literature & outdoor posters available
- Cartons can easily be stored in standard warehouse racks
- No glass or other breakable item in carton

► Logistic Info

Pallet Specification 40' HC	Dimension	Weight
Ctn. 1 of 2: 14 units/pallet	162 x 62 x 125cm 63.77" x 24.4" x 49.21"	400 kg. 880 lbs.
Ctn. 2 of 2: 18 units/pallet	162 x 124 x 125cm 63.77" x 48.81" x 49.21"	750 kg. 1,650 lbs.

Individual Selling Unit	Dimension	Weight
Carton 1	162 x 62 x 9cm 63.8" x 24.4" x 3.54"	30 kg 66 lbs

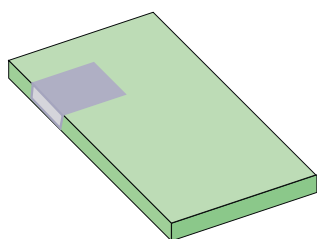

Carton 1

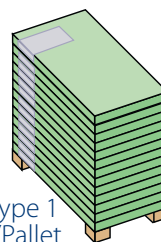

Pallet type 1
12 Pcs/Pallet

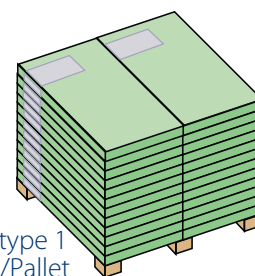

Pallet type 1
24 Pcs/Pallet

Container Specification	Units	Weight
40' Hi Cube	600	19,100 kg. 42,020 lbs.

* 14 pallets of 12 units per pallet & 18 pallets of 24 units per pallet

Europe
UK
Israel
USA
Australia
Far East



PALRAM APPLICATIONS LTD.
Ramat Yohanan, 30035, ISRAEL
Tel ► (972) 4 8459844
Fax ► (972) 4 8459848
applications@palram.com

EUROPE
PALRAM EUROPE LTD.
Tel ► (44) 1302 380 777
Fax ► (44) 1302 380 788
sales.europe@palram.com

ISRAEL
PALRAM ISRAEL LTD.
Tel ► (972) 4 8459 900
Fax ► (972) 4 8459 980
palram@palram.com

USA
PALRAM AMERICAS
Tel ► 610 285 9918
Fax ► 610 285 9928
palramamericas@palram.com

www.palram.com

GREEN LINE GREENHOUSE 6' x 4'

HOME & GARDEN
PRODUCTS



► Model: Green Line 6'x4' Greenhouse

Assembled dimensions: 140cm L x 193cm W x 203cm H
(55.11" L x 75.98" W x 79.92" H)

Manufacture: Palram Applications
Product line: Green Line Series

Mfg.item#: 701058
Item UPC: 894275000625
EAN: 7290010027507

Targeted retail price:



► Product Highlights

- Single Layer, Crystal Clear Polycarbonate panels are virtually unbreakable
- 197cm/6.5' of head room
- Green galvanized steel base and manual roof vent included
- Average set-up time 4 to 5 hours
- Sturdy, corrosion-resistant aluminum frame
- Forest green painted for added aesthetic quality
- 100% UV Protection, blocks out 99.9%

► Merchandising Highlights

- Polypropylene cartons allows outdoor storage
- Full-color labels reduce need for POP literature
- POP literature & outdoor posters available
- Cartons can easily be stored in standard warehouse racks
- No glass or other breakable item in carton

► Logistic Info

Pallet Specification 40' HC	Dimension	Weight
Ctn. 1 of 2: 14 units/pallet	162 x 62 x 125cm 63.77" x 24.4" x 49.21"	400 kg. 880 lbs.
Ctn. 2 of 2: 18 units/pallet	162 x 124 x 125cm 63.77" x 48.81" x 49.21"	750 kg. 1,650 lbs.

Individual Selling Unit	Dimension	Weight
Carton 1	162 x 62 x 9cm 63.8" x 24.4" x 3.54"	30 kg 66 lbs

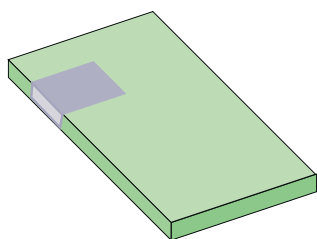

Carton 1

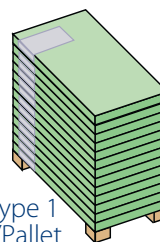

Pallet type 1
12 Pcs/Pallet

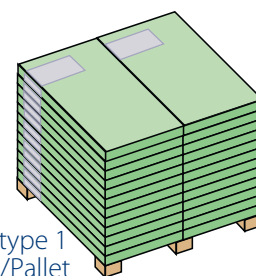

Pallet type 1
24 Pcs/Pallet

Container Specification	Units	Weight
40' Hi Cube	600	19,100 kg. 42,020 lbs.

* 14 pallets of 12 units per pallet & 18 pallets of 24 units per pallet

Europe
UK
Israel
USA
Australia
Far East



PALRAM APPLICATIONS LTD.
Ramat Yohanan, 30035, ISRAEL
Tel ► (972) 4 8459844
Fax ► (972) 4 8459848
applications@palram.com

EUROPE
PALRAM EUROPE LTD.
Tel ► (44) 1302 380 777
Fax ► (44) 1302 380 788
sales.europe@palram.com

ISRAEL
PALRAM ISRAEL LTD.
Tel ► (972) 4 8459 900
Fax ► (972) 4 8459 980
palram@palram.com

USA
PALRAM AMERICAS
Tel ► 610 285 9918
Fax ► 610 285 9928
palramamericas@palram.com

www.palram.com

MULTI LINE GREENHOUSE 6' x 4'



► Model: Multi Line 6'x4' Greenhouse

Assembled dimensions: 140cm L x 193cm W x 203cm H
(55.11"L x 75.98"W x 79.92"H)

Manufacture: Palram Applications
Product line: Multi Line Series

Mfg.item#: 701059
Item UPC: 894275000878
EAN: 7290010027620

Targeted retail price:



► Product Highlights

- Multi wall clear Polycarbonate panels are virtually unbreakable
- 197cm/6.5' of head room
- Galvanized steel base and manual roof vent included
- Average set-up time 4 to 5 hours
- Sturdy, corrosion-resistant aluminum frame
- 100% UV Protection, blocks out 99.9% of harmful solar radiation

► Merchandising Highlights

- Polypropylene packages allows outdoor storage
- Full-color labels reduce need for POP literature
- POP literature & outdoor posters available
- Packages can easily be stored in standard warehouse racks
- No glass or other breakable item in carton
- Excellent thermal isolation with the polycarbonate Multi Wall panels.

► Logistic Info

Pallet Specification 40' HC	Dimension	Weight
Pallet type 1 : 14 pallet/11 units	162 x 62 x 125cm 63.77" x 24.4" x 49.21"	380 kg. 836 lbs.
Pallet type 2 : 18 pallet/22 units	18 x 129 x 125cm 46.45" x 50.78" x 49.21"	730 kg. 1,606 lbs

Individual Selling Unit	Dimension	Weight
Carton 1	162 x 62 x 10cm 63.8" x 24.4" x 3.93"	31 kg 68.20 lbs

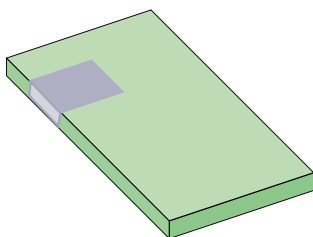

Carton 1

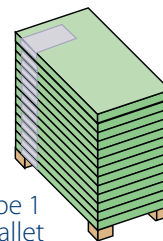

Pallet type 1
11 Pcs/Pallet

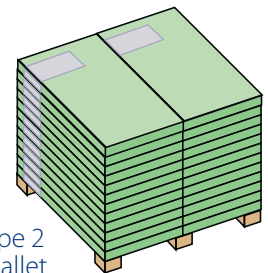

Pallet type 2
22 Pcs/Pallet

Container Specification	Units	Weight
40' Hi Cube	550	18,400 kg. 40,480 lbs.

Europe
UK
Israel
USA
Australia
Far East



PALRAM APPLICATIONS LTD.
Ramat Yohanan, 30035, ISRAEL
Tel ► (972) 4 8459844
Fax ► (972) 4 8459848
applications@palram.com

EUROPE
PALRAM EUROPE LTD.
Tel ► (44) 1302 380 777
Fax ► (44) 1302 380 788
sales.europe@palram.com

ISRAEL
PALRAM ISRAEL LTD.
Tel ► (972) 4 8459 900
Fax ► (972) 4 8459 980
palram@palram.com

USA
PALRAM AMERICAS
Tel ► 610 285 9918
Fax ► 610 285 9928
palramamericas@palram.com

www.palram.com

SILVER LINE GREENHOUSE 6' x 2'

HOME & GARDEN
PRODUCTS

PALRAM

► Model: Silver Line 6'x2' Greenhouse

Assembled dimensions: 65cm Lx193cm W x 203cmH
(25.6"L x 75.98"W x 79.92"H)

Manufacture: Palram Applications
Product line: Silver Line Series

Mfg.item#: 700823
Item UPC: 894275000885
EAN: 7290010027293

Targeted retail price:



► Product Highlights

- Single Layer, Crystal Clear Polycarbonate panels are virtually unbreakable
- 197cm/6.5' of head room
- Green galvanized steel base and manual roof vent included
- Average set-up time 4 to 5 hours
- Sturdy, corrosion-resistant aluminum frame
- Forest green painted for added aesthetic quality
- 100% UV Protection, blocks out 99.9% of harmful solar radiation

► Merchandising Highlights

- Polypropylene cartons allows outdoor storage
- Full-color labels reduce need for POP literature
- POP literature & outdoor posters available
- Cartons can easily be stored in standard warehouse racks
- No glass or other breakable item in carton

► Logistic Info

Pallet Specification 40' HC	Dimension	Weight
Pallet type 1 : 28 units/pallet	162 x 124 x 120cm 63.77" x 48.81" x 47.24"	700 kg. 1,540 lbs.
Pallet type 2 : 14 units/pallet	162 x 62 x 120cm 63.77" x 48.81" x 47.24"	370 kg. 814 lbs.

Individual Selling Unit	Dimension	Weight
Carton 1	162 x 62 x 9cm 63.77" x 24.4" x 3.54"	24 kg. 53 lbs.

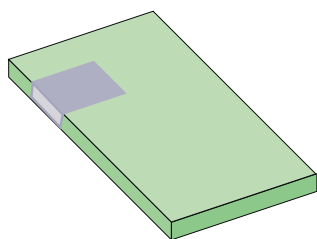

Individual unit comes in one carton
(Aluminum frame, Galvanized steel base, Glazing panels)

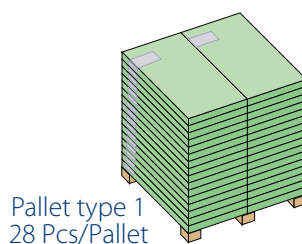

Pallet type 1
28 Pcs/Pallet

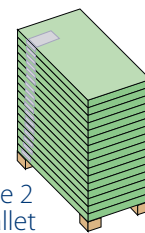

Pallet type 2
14 Pcs/Pallet

Container Specification	Units	Weight
40' Hi Cube	700	17,800 kg. 39,160 lbs.

* 18 pallets of 28 units per pallet / 14 pallets of 14 units per pallet

Europe
UK
Israel
USA
Australia
Far East



PALRAM APPLICATIONS LTD.
Ramat Yohanan, 30035, ISRAEL
Tel ► (972) 4 8459844
Fax ► (972) 4 8459848
applications@palram.com

EUROPE
PALRAM EUROPE LTD.
Tel ► (44) 1302 380 777
Fax ► (44) 1302 380 788
sales.europe@palram.com

ISRAEL
PALRAM ISRAEL LTD.
Tel ► (972) 4 8459 900
Fax ► (972) 4 8459 980
palram@palram.com

USA
PALRAM AMERICAS
Tel ► 610 285 9918
Fax ► 610 285 9928
palramamericas@palram.com

www.palram.com



Accessories

ACCESSORIES SERIES

ACCESSORIES GREENHOUSE

HOME & GARDEN
PRODUCTS



Shade Kit

Reflectiv aluminum shade cloth clips to aluminum frame inside the greenhouse. Can easily be re-positioned for changing seasons or crops.

Mfg.Item#: 700560

Assembled Dimensions: 240x200cm / 94.5"x78.7"

Bag Dimensions: 30x22cm / 11.8"x8.7"

Weight: 0.6 kg
1.3 lbs. / ea.

UPC: 894275000199

EAN: 7290010027262

Targeted retail price:



Shelf Kit

Clamps to aluminum frame inside the greenhouse. Can easily be re-positioned for changing seasons or crops.

Mfg.Item#: 700550

Assembled Dimensions: 126x30x3cm / 1.2"x 49.6"x11.8"

Package Dimensions: 65x31x6cm / 25.6"x12.2"x2.4"

Weight: 2.5 kg.
5.5 lbs. / ea.

UPC: 894275000189

EAN: 7290010027255

Targeted retail price:



Shelving System

Two shelves for greenhouse plants. Allows you creating well organized space. Durable galvanized steel- rust proof. Can hold heavy weight.

Mfg.Item#: 701152

Assembled Dimensions: 114x50x80cm / 44.9" x 19.6"x31.5"

Package Dimensions: 116x51x7cm / 45.66"x20.1"x2.5"

Weight: 10 kg.
22 lbs. / ea.

UPC: 894275000861

EAN: 7290010027781

Targeted retail price:



Plant Hangers

Simply insert into channel in roof rafters and twist to install. Used to install shade kit, but designed to also hold standard hanging baskets or pots.

Mfg.Item#: 700650

Plastic Bag: 16x10cm / 6.29"x4"

Pcs./Bag:10

Weight: 0.1 kg.
0.22 lbs. / bag

UPC: 894275000168

EAN: 7290010027279

Targeted retail price:



Manual Vent Kit

Doubles amount of ventilation in roof area. Helps to provide additional airflow and aid cooling during warmer days.

Mfg.Item#: 700451

Carton: 66x55x4cm / 26.0"x21.65"x1.6"

Weight: 2 kg.
4.4 lbs. / ea.

UPC: 894275000175

EAN: 7290010027248

Targeted retail price:



Semi-Automatic Vent Arm

Engineered specifically to replace manual vent arm in the Silver Line Greenhouse. Spring tensions and temperature-sensitive wax optimised for size and weight of vent. Opens vent at desired temperature, closes when temperature cools.

Mfg.Item#: 94986

Carton: 40x7x5cm / 15.75"x2.75"x2"

Weight: 0.6 kg.
1.4 lbs. / ea.

UPC: 894275000304

EAN: 7290010027347

Targeted retail price:

* Open's 85°, 32cm

Europe
UK
Israel
USA
Australia
Far East



PALRAM APPLICATIONS LTD.
Ramat Yohanan, 30035, ISRAEL
Tel ► (972) 4 8459844
Fax ► (972) 4 8459848
applications@palram.com

EUROPE
PALRAM EUROPE LTD.
Tel ► (44) 1302 380 777
Fax ► (44) 1302 380 788
sales.europe@palram.com

ISRAEL
PALRAM ISRAEL LTD.
Tel ► (972) 4 8459 900
Fax ► (972) 4 8459 980
palram@palram.com

USA
PALRAM AMERICAS
Tel ► 610 285 9918
Fax ► 610 285 9928
palramamericas@palram.com

tww.palram.com



Lean-To

MINI GREENHOUSES SERIES

LEAN-TO GREENHOUSE 4' x 2'



► Model: Silver Lean-To 4'x2' Greenhouse

Assembled dimensions: 71cm L x 129cm W x 165cm H
(27.95"L x 50.78"W x 64.96"H)

Manufacture: Palram Applications
Product line: Lean-To Series

Mfg.item#: 700492
Item UPC: 894275000274
EAN: 7290010027071

Targeted retail price:



► Product Highlights

- Single Layer, Crystal Clear Polycarbonate panels are virtually unbreakable
- Galvanized base, manual vent and sliding door included
- Perfect size for apartment or small backyards patio
- Great for protecting potted and collectable plants
- Average set-up time 1 to 2 hours
- 100% UV Protection blocks out 99.9% of harmful solar radiation

► Merchandising Highlights

- Polypropylene cartons allow outdoor storage
- Full-color labels reduce need for POP literature
- POP literature & outdoor posters available
- Cartons can easily be stored in standard warehouse racks
- No glass or other breakable item in carton

► Logistic Info

Pallet Specification 40' HC	Dimension	Weight
Pallet type 1 : 32 units/pallet	151 x 130 x 127cm 59.44" x 51.18" x 50"	500 kg. 1,100 lbs.
Pallet type 2 : 16 units/pallet	151 x 64 x 127cm 59.44" x 25.19" x 150"	260 kg. 572 lbs.

Individual Selling Unit	Dimension	Weight
Carton 1	151 x 62 x 7cm 59.44" x 24.4" x 2.75"	14 kg. 30.8 lbs.

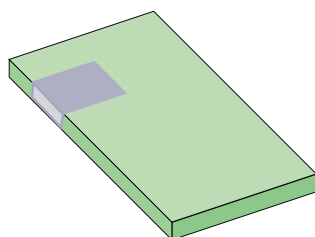

Individual unit comes in one carton

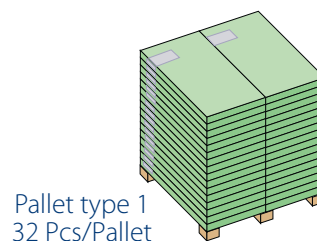

Pallet type 1
32 Pcs/Pallet

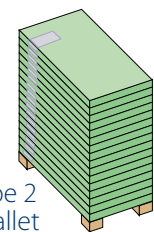

Pallet type 2
16 Pcs/Pallet

Container Specification	Units	Weight
40' Hi Cube	800	12,584 kg 27,684 lbs.

* 18 pallets of 32 units per pallet / 14 pallets of 16 units per pallet

Europe
UK
Israel
USA
Australia
Far East



PALRAM APPLICATIONS LTD.
Ramat Yohanan, 30035, ISRAEL
Tel ► (972) 4 8459844
Fax ► (972) 4 8459848
applications@palram.com

EUROPE
PALRAM EUROPE LTD.
Tel ► (44) 1302 380 777
Fax ► (44) 1302 380 788
sales.europe@palram.com

ISRAEL
PALRAM ISRAEL LTD.
Tel ► (972) 4 8459 900
Fax ► (972) 4 8459 980
palram@palram.com

USA
PALRAM AMERICAS
Tel ► 610 285 9918
Fax ► 610 285 9928
palramamericas@palram.com

www.palram.com

LEAN-TO GREENHOUSE 4' x 2'



► Model: Multi Lean-To 4'x2' Greenhouse

Assembled dimensions: 71cm L x 129cm W x 165cm H
(27.95"L x 50.78"W x 64.96"H)

Manufacture: Palram Applications
Product line: Lean-To Series

Mfg.item#: 700986
Item UPC: 894275000335
EAN: 7290010027460

Targeted retail price:



► Product Highlights

- Polycarbonate panels are virtually unbreakable
- Galvanized base, manual vent and sliding door included
- Perfect size for apartment or small backyards patio
- Great for protecting potted and collectable plants
- Average set-up time 1 to 2 hours
- 100% UV Protection, blocks out 99.9% of harmful solar radiation

► Merchandising Highlights

- Polypropylene cartons allow outdoor storage
- Full-color labels reduce need for POP literature
- POP literature & outdoor posters available
- Cartons can easily be stored in standard warehouse racks
- No glass or other breakable item in carton

► Logistic Info

Pallet Specification 40' HC	Dimension	Weight
Pallet type 1 : 32 units/pallet	151 x 130 x 127cm 59.44" x 51.18" x 50"	500 kg. 1,100 lbs.
Pallet type 2 : 16 units/pallet	151 x 64 x 127cm 59.44" x 25.19" x 150"	260 kg. 572 lbs.

Individual Selling Unit	Dimension	Weight
Carton 1	151 x 62 x 7cm 59.44" x 24.4" x 2.75"	14 kg. 30.8 lbs.

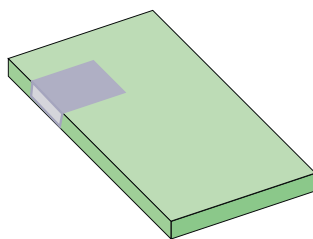

Individual unit comes in one carton

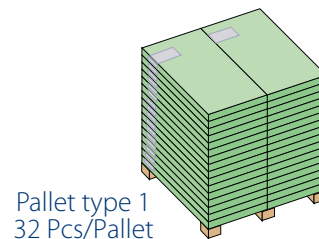

Pallet type 1
32 Pcs/Pallet

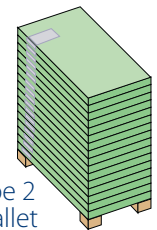

Pallet type 2
16 Pcs/Pallet

Container Specification	Units	Weight
40' Hi Cube	800	12,584 kg 27,684 lbs.

* 18 pallets of 32 units per pallet / 14 pallets of 16 units per pallet

Europe
UK
Israel
USA
Australia
Far East



PALRAM APPLICATIONS LTD.
Ramat Yohanan, 30035, ISRAEL
Tel ► (972) 4 8459844
Fax ► (972) 4 8459848
applications@palram.com

EUROPE
PALRAM EUROPE LTD.
Tel ► (44) 1302 380 777
Fax ► (44) 1302 380 788
sales.europe@palram.com

ISRAEL
PALRAM ISRAEL LTD.
Tel ► (972) 4 8459 900
Fax ► (972) 4 8459 980
palram@palram.com

USA
PALRAM AMERICAS
Tel ► 610 285 9918
Fax ► 610 285 9928
palramamericas@palram.com

www.palram.com

LEAN-TO GREENHOUSE 4' x 2'



► Model: Green Lean-To 4'x2' Greenhouse

Assembled dimensions: 71cm Lx129cm W x 165cm H
(27.95"L x 50.78"W x 64.96"H)

Manufacture: Palram Applications
Product line: Lean-To Series

Mfg.item#: 700915
Item UPC: 894275000328
EAN: 7290010027477

Targeted retail price:



► Product Highlights

- Single Layer, Crystal Clear Polycarbonate panels are virtually unbreakable
- Galvanized base, manual vent and sliding door included
- Perfect size for apartment or small backyards patio
- Great for protecting potted and collectable plants
- Average set-up time 1 to 2 hours
- Green painted aluminum frame
- 100% UV Protection blocks out 99.9% of harmful solar radiation

► Merchandising Highlights

- Polypropylene cartons allow outdoor storage
- Full-color labels reduce need for POP literature
- POP literature & outdoor posters available
- Cartons can easily be stored in standard warehouse racks
- No glass or other breakable item in carton

► Logistic Info

Pallet Specification 40' HC	Dimension	Weight
Pallet type 1 : 32 units/pallet	151 x 130 x 127cm 59.44" x 51.18" x 50"	500 kg. 1,100 lbs.
Pallet type 2 : 16 units/pallet	151 x 64 x 127cm 59.44" x 25.19" x 150"	260 kg. 572 lbs.

Individual Selling Unit	Dimension	Weight
Carton 1	151 x 62 x 7cm 59.44" x 24.4" x 2.75"	14 kg. 30.8 lbs.

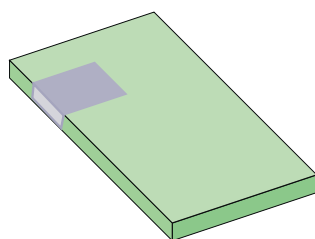

Individual unit comes in one carton

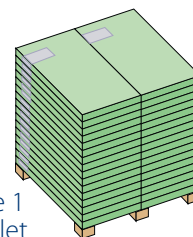

Pallet type 1
32 Pcs/Pallet

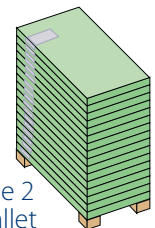

Pallet type 2
16 Pcs/Pallet

Container Specification	Units	Weight
40' Hi Cube	800	12,584 kg 27,684 lbs.

* 18 pallets of 32 units per pallet / 14 pallets of 16 units per pallet

Europe
UK
Israel
USA
Australia
Far East



PALRAM APPLICATIONS LTD.
Ramat Yohanan, 30035, ISRAEL
Tel ► (972) 4 8459844
Fax ► (972) 4 8459848
applications@palram.com

EUROPE
PALRAM EUROPE LTD.
Tel ► (44) 1302 380 777
Fax ► (44) 1302 380 788
sales.europe@palram.com

ISRAEL
PALRAM ISRAEL LTD.
Tel ► (972) 4 8459 900
Fax ► (972) 4 8459 980
palram@palram.com

USA
PALRAM AMERICAS
Tel ► 610 285 9918
Fax ► 610 285 9928
palramamericas@palram.com

www.palram.com

LEAN-TO GREENHOUSE 4' x 2'



► Model: Lean-To 4'x2' Greenhouse (Combined Glazing)

Assembled dimensions: 71cm L x 129cm W x 165cm H
(27.95"L x 50.78"W x 64.96"H)

Manufacture: Palram Applications
Product line: Lean-To Series

Mfg.item#: 701095
EAN: 7290010027644

Targeted retail price:



► Product Highlights

- Single Layer, Crystal Clear Polycarbonate panels are virtually unbreakable
- Galvanized base, manual vent and sliding door included
- Perfect size for apartment or small backyards patio
- Great for protecting potted and collectable plants
- Average set-up time 1 to 2 hours
- Green painted aluminum frame
- 100% UV Protection blocks out 99.9% of harmful solar radiation

► Merchandising Highlights

- Polypropylene cartons allow outdoor storage
- Full-color labels reduce need for POP literature
- POP literature & outdoor posters available
- Cartons can easily be stored in standard warehouse racks
- No glass or other breakable item in carton

► Logistic Info

Pallet Specification 40' HC	Dimension	Weight
Pallet type 1 : 32 units/pallet	151 x 130 x 127cm 59.44" x 51.18" x 50"	500 kg. 1,100 lbs.
Pallet type 2 : 16 units/pallet	151 x 64 x 127cm 59.44" x 25.19" x 150"	260 kg. 572 lbs.

Individual Selling Unit	Dimension	Weight
Carton 1	151 x 62 x 7cm 59.44" x 24.4" x 2.75"	14 kg. 30.8 lbs.

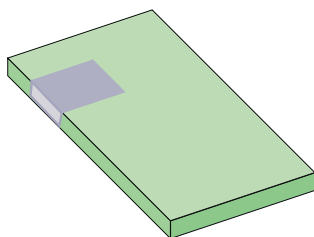

Individual unit comes in one carton

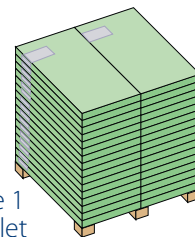

Pallet type 1
32 Pcs/Pallet

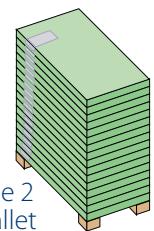

Pallet type 2
16 Pcs/Pallet

Container Specification	Units	Weight
40' Hi Cube	800	12,584 kg 27,684 lbs.

* 18 pallets of 32 units per pallet / 14 pallets of 16 units per pallet

Europe
UK
Israel
USA
Australia
Far East



PALRAM APPLICATIONS LTD.
Ramat Yohanan, 30035, ISRAEL
Tel ► (972) 4 8459844
Fax ► (972) 4 8459848
applications@palram.com

EUROPE
PALRAM EUROPE LTD.
Tel ► (44) 1302 380 777
Fax ► (44) 1302 380 788
sales.europe@palram.com

ISRAEL
PALRAM ISRAEL LTD.
Tel ► (972) 4 8459 900
Fax ► (972) 4 8459 980
palram@palram.com

USA
PALRAM AMERICAS
Tel ► 610 285 9918
Fax ► 610 285 9928
palramamericas@palram.com

www.palram.com



Cold Frame

COLD FRAME SERIES

COLD FRAME GREENHOUSE 3' x 3'



► Model: Cold Frame 3'x3' Greenhouse

Assembled dimensions: 108cm Lx105cm W x 53cm H
(42.5"L x 41.3"W x 20.8"H)

Manufacture: Palram Applications
Product line: Cold Frame Series

Mfg.item#: 700872
Item UPC: 894275000229
EAN: 7290010027286

Targeted retail price:



► Product Highlights

- Polycarbonate panels are virtually unbreakable
- 100% UV protection
- Two removable doors for easy access
- Perfect for starting seedling's and plant protect from animals
- Can be anchored to the ground or raised planter beds
- Corrosion-resistant aluminum frame
- Easy set up - approx 1/2 hour

► Merchandising Highlights

- Print carton can be used as a POP.
- Study, re-usable cardboard allow for off-season storage
- POP literature & outdoor posters available
- No glass or other breakable item in carton

► Logistic Info

Pallet Specification	Units	Dimension	Weight
Pallet	48	110.5 x 114 x 250cm 43.5" x 44.38" x 98.42"	360 kg. 792 lbs.



Individual Selling Unit	Dimension	Weight
Carton 1	110 x 57 x 10cm 43.3" x 22.44" x 3.93"	7 kg. 15.4 lbs.



Individual Unit

Container Specification	Units	Weight
40' Hi Cube	1056*	8,000 kg. 17,600 lbs.

* 22 pallets of 48 units per pallet

Europe
UK
Israel
USA
Australia
Far East



PALRAM APPLICATIONS LTD.
Ramat Yohanan, 30035, ISRAEL
Tel ► (972) 4 8459844
Fax ► (972) 4 8459848
applications@palram.com

EUROPE
PALRAM EUROPE LTD.
Tel ► (44) 1302 380 777
Fax ► (44) 1302 380 788
sales.europe@palram.com

ISRAEL
PALRAM ISRAEL LTD.
Tel ► (972) 4 8459 900
Fax ► (972) 4 8459 980
palram@palram.com

USA
PALRAM AMERICAS
Tel ► 610 285 9918
Fax ► 610 285 9928
palramamericas@palram.com

www.palram.com

COLD FRAME GREENHOUSE 3.3' x 1.7'



► Model: Cold Frame Single 3.3'x1.7' Greenhouse

Assembled dimensions: 100cm Lx50.5cm W x 41cm H
(39.6"L x 20.4"W x 16.2"H)

Manufacture: Palram Applications
Product line: Cold Frame Series

Mfg.item#: 701148
Item UPC: 894275000854
EAN: 7290010027774

Targeted retail price:



► Product Highlights

- Perfect for starting seedling's and plant protection
- Transparent door- allows maximum sun exposure
- Offers 0.5 sq.meters growing area
- Should be anchored to the ground using product's corners
- Rust proof materials
- Easy set up- approx 1/2 hour
- Assembly instructions included

► Merchandising Highlights

- POP literature & outdoor posters available
- No glass or other breakable item in carton
- Stylish cost-efficient design
- Compact package will fit in any car

► Logistic Info

Pallet Specification	Units	Dimension	Weight
Pallet : 22 units/pallet	66	105 x 111 x 250cm 41" x 44" x 98"	160 kg. 360 lbs.

Individual Selling Unit	Dimension	Weight
Carton	105 x 55 x 7cm 41" x 22" x 3"	2 kg. 4.4 lbs.

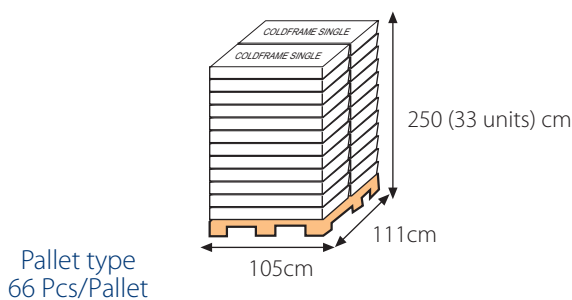
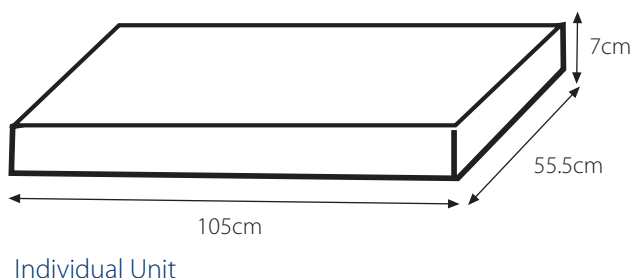

Container Specification	Units	Pallets	Weight
40' Hi Cube	1,496	20	3,560 kg 7,840 lbs.

* 22 pallets of 66 units per pallet

Europe
UK
Israel
USA
Australia
Far East



PALRAM APPLICATIONS LTD.
Ramat Yohanan, 30035, ISRAEL
Tel ► (972) 4 8459844
Fax ► (972) 4 8459848
applications@palram.com

EUROPE
PALRAM EUROPE LTD.
Tel ► (44) 1302 380 777
Fax ► (44) 1302 380 788
sales.europe@palram.com

ISRAEL
PALRAM ISRAEL LTD.
Tel ► (972) 4 8459 900
Fax ► (972) 4 8459 980
palram@palram.com

USA
PALRAM AMERICAS
Tel ► 610 285 9918
Fax ► 610 285 9928
palramamericas@palram.com

www.palram.com



Sun Tunnel

MINI GREENHOUSES SERIES

► **Model:**
Sun Tunnel Mini Greenhouse

Assembled dimensions: 113cm L x 50cm W x 30cm H
(44.5"L x 20"W x 12"H)

Manufacture: Palram Applications
Product line: Sun Tunnel series

Mfg.item#: 701050
Item UPC: 894275000601
EAN: 7290010027415

Targeted retail price:



► **Product Highlights**

- Ready for use-no assembly required
- Smart stacking allows effortless pulling out of the pile
- Clear- maximum light transmission for your plants
- Lightweight- less than 1 Kg.
- Two built-in air vent (front and rear)
- High impact, weather and UV resistant
- Supplied with four matching spikes

► **Merchandising Highlights**

- Full-color display carton reduces need for POP literature
- POP literature& outdoor posters available
- Display cartons can easily be stored in standard warehouse racks
- No glass or other breakable item in carton

► **Logistic Info**

Individual Selling Unit	Dimension	Weight
1 Carton/35 Units	115 x 56 x 80.5cm 45.27" x 22.04" x 31.7"	33 kg. 72.6 lbs.

Pallet Specification	Dimension	Weight
6 Carton/35 Units (40' Hi Cube design)	115 x 117 x 252cm 45.27" x 46.06" x 99.21"	215 kg. 473 lbs.

Container Specification	Units	Pallets	Weight
40' Hi Cube	4,200	20	4,300 kg. 9,460 lbs.



► Individual unit



► Master carton

Front view



Side view



► Pallet design

Packed pallet



► Model: Seed Tray for Sun Tunnel

Assembled dimensions: 110cm Lx50cm W x 8.6cm H
(43.5"L x 20"W x 3.4"H)

Manufacture: Palram Applications
Product line: Sun Tunnel series

Mfg.item#: 701107
Item UPC: 894275000618
EAN: 7290010027514

Targeted retail price:



► Product Highlights

- Ready for use-no assembly required
- Smart stacking allows effortless pulling out of the pile
- Clear- maximum light transmission for your plants
- Lightweight- approximately 0.5 Kg.
- High impact, weather and UV resistant
- Supplies with four sun tunnel matching connectors

► Merchandising Highlights

- Full-color display carton reduces need for POP literature
- POP literature& outdoor posters available
- Display cartons can easily be stored in standard warehouse racks
- No glass or other breakable item in carton

► Logistic Info

Individual Selling Unit	Dimension	Weight
1 Carton/35 Units	116 x 56 x 40cm 47.4" x 22" x 15.8"	22 kg. 48.5 lbs.

Pallet Specification	Dimension	Weight
12 Carton/35 Units (40' Hi Cube design)	115 x 117 x 250cm 45.3" x 46" x 98.5"	280 kg. 616 lbs.

Container Specification	Units	Pallets	Weight
40' Hi Cube	8,400	20	5,600 kg 12,320 lbs.

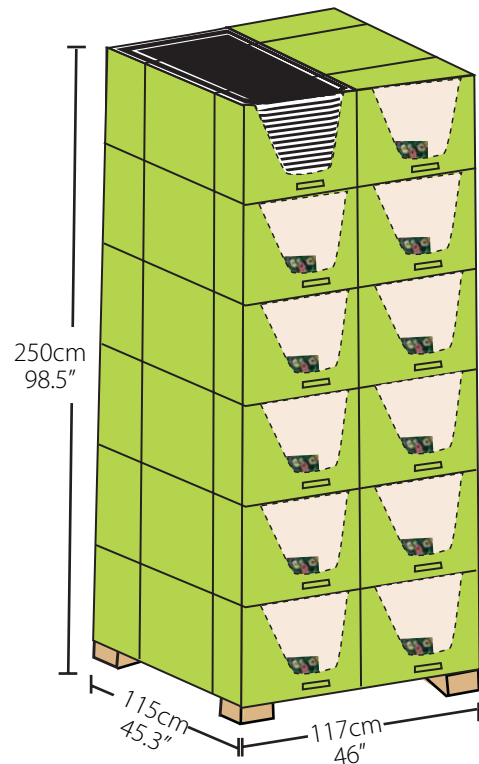

Sun Tunnel Double

MINI GREENHOUSE



► Model: Sun Tunnel Mini Greenhouse

Assembled dimensions: 115cm L x 69.5cm W x 35cm H
(45.27"L x 27.36"W x 13.77"H)

Manufacture: Palram Applications
Product line: Sun Tunnel series

Mfg.item#: 701151
Item UPC:
EAN: 7290010027828

Targeted retail price:



► Product Highlights

- Ready for use-no assembly required
- Smart stacking allows effortless pulling out of the pile
- Clear- maximum light transmission for your plants
- Lightweight- only 1.1 Kg.
- Four built-in air vent (front and rear)
- High impact, weather and UV resistant
- Supplied with four matching spikes

► Merchandising Highlights

- Full-color display carton reduces need for POP literature
- POP literature& outdoor posters available
- Display cartons can easily be stored in standard warehouse racks
- No glass or other breakable item in carton

► Logistic Info

Individual Selling Unit	Dimension	Weight
1 Carton/65 Units	117 x 76 x 125cm 46.06" x 29.92" x 49.21"	90 kg. 198 lbs.

Container Specification	Units	Pallets	Weight
40' Hi Cube	3,900	60 (30x2)	5,400 kg. 11,880 lbs.

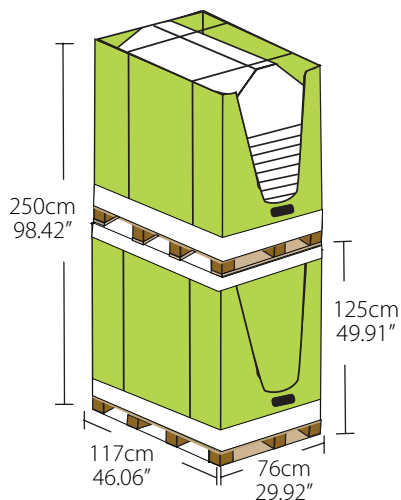

Europe
UK
Israel
USA
Australia
Far East



PALRAM APPLICATIONS LTD.
Ramat Yohanan, 30035, ISRAEL
Tel ► (972) 4 8459844
Fax ► (972) 4 8459848
applications@palram.com

EUROPE
PALRAM EUROPE LTD.
Tel ► (44) 1302 380 777
Fax ► (44) 1302 380 788
sales.europe@palram.com

ISRAEL
PALRAM ISRAEL LTD.
Tel ► (972) 4 8459 900
Fax ► (972) 4 8459 980
palram@palram.com

USA
PALRAM AMERICAS
Tel ► 610 285 9918
Fax ► 610 285 9928
palramamericas@palram.com

www.palram.com



Special Garden Products

SMALL GARDEN PRODUCTS SERIES

Potato Planter

SPECIAL GARDEN PRODUCT



► Model: Potato Planter

Assembled dimensions: 45cm Ø x 62cm H
(17.71"Ø x 24.40" H)

Manufacture: Palram Applications
Product line: Special Garden Product

Mfg.item#: 701130
Item UPC:
EAN: 7290010027163

Targeted retail price:



► Product Highlights

- Made from polypropylene/ ABS material
- Frost resistant
- Ideal for growing potatoes on a patio or balcony
- Easy to assemble by one person
- Requires just 5 seed potatoes in approx. 90 litres of compost (not supplied)

► Merchandising Highlights

- POP literature & outdoor posters available
- Display cartons can easily be stored in standard warehouse racks
- No glass or other breakable item in carton

► Logistic Info

Master package	Dimension	Weight
5 individual units	62cm L x 49cm W x 80cm H 24.4" x 19.29" x 31.49"	10 kg. 44 lbs.

Individual Selling Unit	Dimension	Weight
Carton	62cm L x 49cm W x 15cm H 24.4" x 19.29" x 5.9"	2 kg. 4.4 lbs.

Pallet specification	Dimension	Weight
12 Master package 60 units per pallet	124cm L x 100cm W x 255cm H 48.81" x 39.37" x 100.39"	150 kg. 330 lbs.

Container Specification	Units	Pallets	Weight
40' Hi Cube	1,200	20	3,000 kg. 6,600 lbs.

* 240 carton package

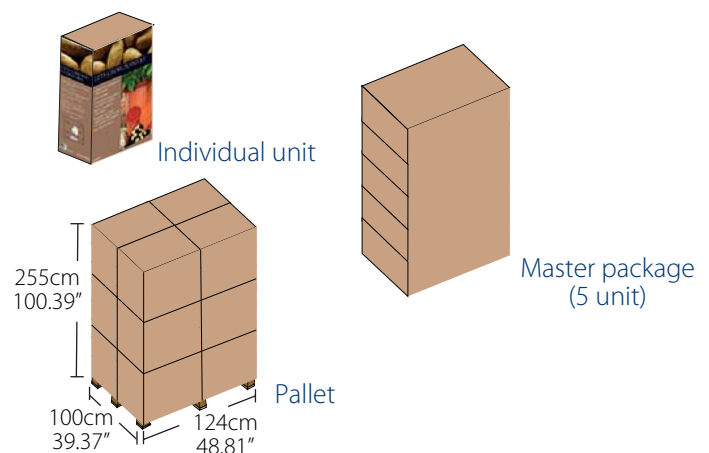

Europe
UK
Israel
USA
Australia
Far East



PALRAM APPLICATIONS LTD.
Ramat Yohanan, 30035, ISRAEL
Tel ► (972) 4 8459844
Fax ► (972) 4 8459848
applications@palram.com

EUROPE
PALRAM EUROPE LTD.
Tel ► (44) 1302 380 777
Fax ► (44) 1302 380 788
sales.europe@palram.com

ISRAEL
PALRAM ISRAEL LTD.
Tel ► (972) 4 8459 900
Fax ► (972) 4 8459 980
palram@palram.com

USA
PALRAM AMERICAS
Tel ► 610 285 9918
Fax ► 610 285 9928
palramamericas@palram.com

www.palram.com

GREENHOUSE 6' x 8'



► Model: Snap - n - Grow

Assembled dimensions: 255cm L x 196cm W x 200cm H
(100.39"L x 77.16"W x 78.74"H)

Manufacture: Palram Applications

Mfg.item#: 701184
Item UPC:
EAN: 7290010027613

Targeted retail price:



► Product Highlights

- Single Layer, Crystal Clear Polycarbonate panels are virtually unbreakable
- 197cm/6.5' of head room
- Average set-up time 2 to 3 hours
- Sturdy, corrosion-resistant aluminum frame
- 100% UV Protection, blocks out 99.9% of harmful solar radiation

► Merchandising Highlights

- Printed carton package can be used as a POP
- POP literature & outdoor posters available
- Cartons can easily be stored in standard warehouse racks
- No glass or other breakable item in carton
- Greenhouse is packed in one package

► Logistic Info

Individual Selling Unit	Dimension	Weight
Carton	128 x 65 x 26cm 50.39" x 25.59" x 10.23"	45 kg. 99 lbs.

Pallet Specification	Dimension	Weight
40' HC		
Pallet	220 x 128 x 120cm	670 kg.
14 units/pallet	86.61" x 50.39" x 47.24"	1,475 lbs.

Individual selling unit

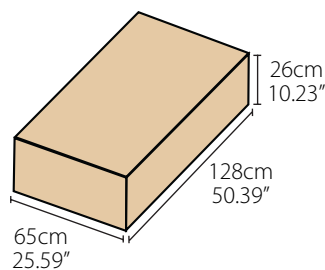

pallet
14 Pcs/Pallet

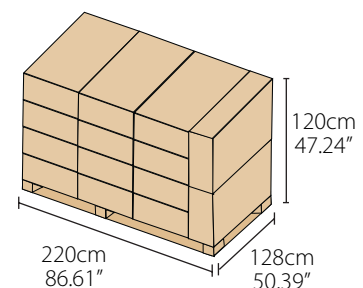

Container Specification	Units	Weight
40' Hi Cube	252	12,060 kg. 26,532 lbs.

* Carton : 18 pallets of 14 units per pallet

Europe
UK
Israel
USA
Australia
Far East



PALRAM APPLICATIONS LTD.
Ramat Yohanan, 30035, ISRAEL
Tel ► (972) 4 8459844
Fax ► (972) 4 8459848
applications@palram.com

EUROPE
PALRAM EUROPE LTD.
Tel ► (44) 1302 380 777
Fax ► (44) 1302 380 788
sales.europe@palram.com

ISRAEL
PALRAM ISRAEL LTD.
Tel ► (972) 4 8459 900
Fax ► (972) 4 8459 980
palram@palram.com

USA
PALRAM AMERICAS
Tel ► 610 285 9918
Fax ► 610 285 9928
palramamericas@palram.com

www.palram.com